

DRAWING FOR CUSTOMER

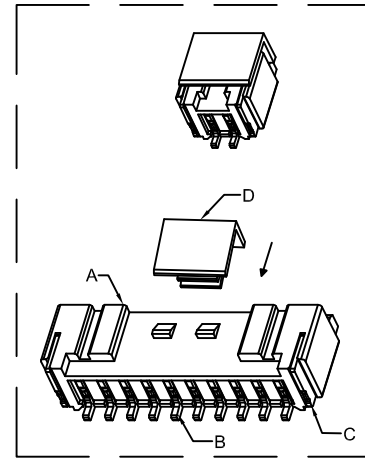
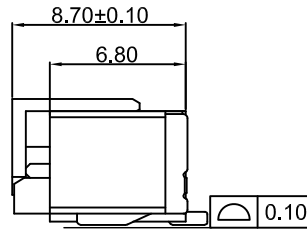
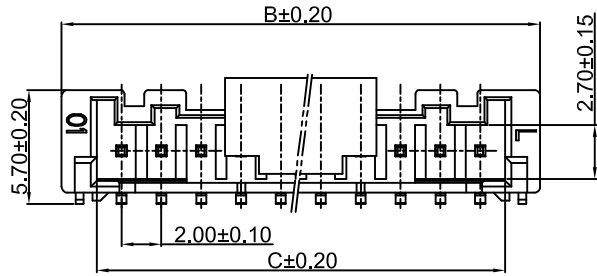

- SPEC.:
- Rated Voltage:250V AC,DC
 - Rated Current:3A AC,DC
 - Withstand Voltage:800V AC/minute
 - Contact Resistance:20mΩ max
 - Insulation Resistance:1000MΩ min
 - Temperature Range:-25℃~+85℃

- Material:
- Insulator(A):P3-PA6T UL94V-0
Color:BGE-Beige
 - Contact Pin(B): Brass
Finish: Tin-plated; over Nickel
 - Solder Tab(C): Brass
Finish: Tin-plated, over Nickel
 - CAP(D): P3-PA6T UL94V-0
- KB934-XX X S R 6 A -P3-BGE -X

Pin No.	1:With CAP 2:Without CAP	Color	Material	Version	Mold No.
T:TUBE 管裝					
R:REEL 卷裝					
P:PE 袋裝					
D:DIP					
S: SMT					
R:Right Angle					
V:Vertical					

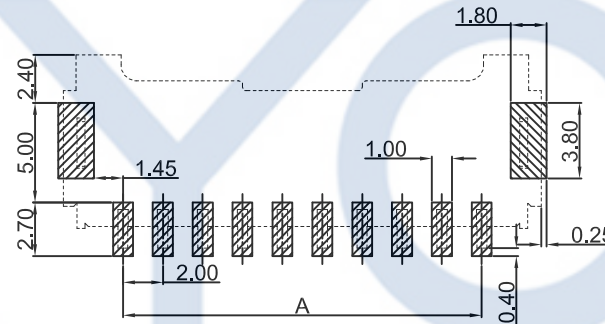
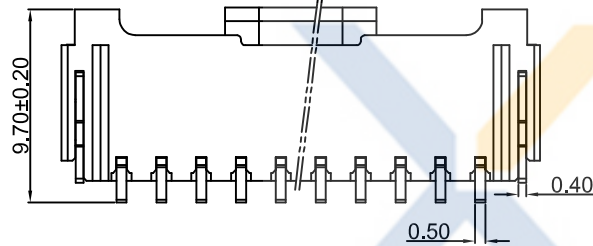

Recommended P.C.B Layout
General Tolerance±0.05



示意图 10~15P

Poles	Dimensions (mm)		
	A	B	C
02	2.00	8.00	4.55
03	4.00	10.00	6.55
04	6.00	12.00	8.55
05	8.00	14.00	10.55
06	10.00	16.00	12.55
07	12.00	18.00	14.55
08	14.00	20.00	16.55
09	16.00	22.00	18.55
10	18.00	24.00	20.55
11	20.00	26.00	22.55
12	22.00	28.00	24.55
13	24.00	30.00	26.55
14	26.00	32.00	28.55
15	28.00	34.00	30.55

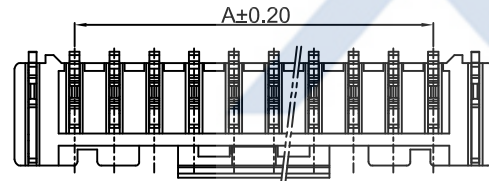
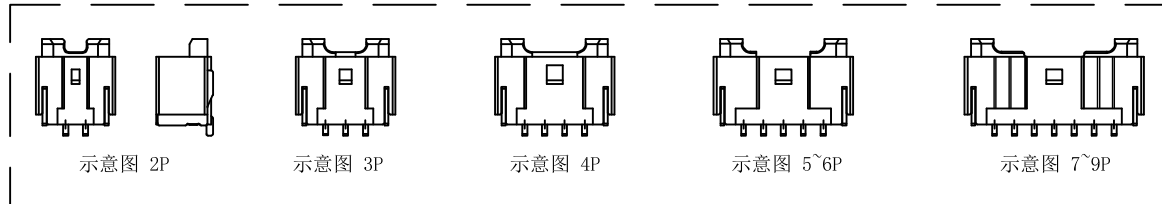

SCALE:2/1

XYCO 东莞市轩业电子科技有限公司
TEL: 0769-8297 9981/2/3 <http://www.XYCO.com.cn>

DATE 日期	VER 版本	CHANGE HISTORY 變更歷史	CHANGED NAME 修改後料號	DRAWING 變更者	TOLERANCE 公差 .X=±0.30 .XX=±0.20 .XXX=±0.10	DRAWING 設計者 Devin	CHECKED 審查 Thomas	APPROVED 核准 William	KB934-XXXSR6A-P3-BGE-X	PART NO. 料號	UNIT 單位 mm	PRODUCT NAME 產品名稱	PA PH2.0mm Wire To Board SMT Right Angle Wafer
2016-08-12	A		KB934-XXXSR6A-P3-BGE-X	Devin									
1	2	3	4	5	6	7	8	9					