

DRAWING FOR CUSTOMER

XY20008- D XX X S V 2 A -C1-BGE

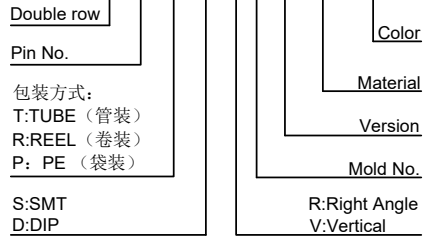

■SPEC.:

- Rated Voltage:250V AC,DC
- Rated Current:3A AC,DC
- Withstand Voltage:800V AC/minute
- Contact Resistance:10mΩ max
- Insulation Resistance:1000MΩ min
- Temperature Range:-25℃~+85℃

■Material :

- Insulator(A): C1-LCP UL94V-0
Color:BGE-Beige
- Contact PIN(B): Phosphor bronze
Finish:Tin-Plated,over Nickel
- CAP(C):LCP UL94V-0;
Color:Beige

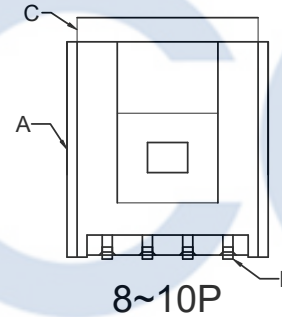
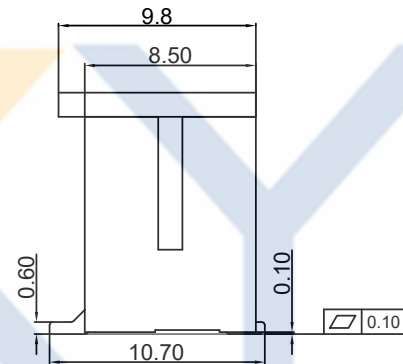
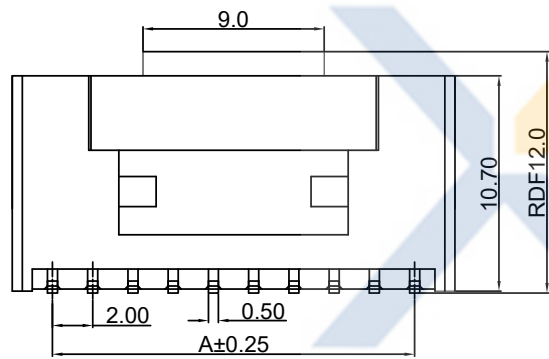
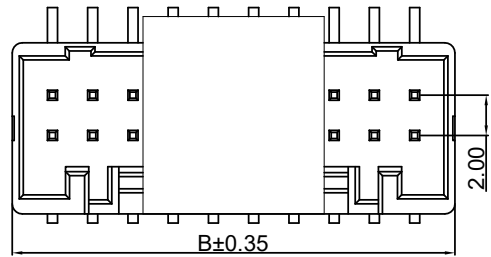

Poles	Dimensions(mm)		Q'ty/Bag
	A	B	
2X04	6.00	10.00	2000PCS
2X05	8.00	12.00	1000PCS
2X06	10.00	14.00	1000PCS
2X07	12.00	16.00	1000PCS
2X08	14.00	18.00	1000PCS
2X09	16.00	20.00	1000PCS
2X10	18.00	22.00	1000PCS
2X11	20.00	24.00	1000PCS
2X12	22.00	26.00	1000PCS
2X13	24.00	28.00	1000PCS
2X14	26.00	30.00	1000PCS
2X15	28.00	32.00	1000PCS
2X16	30.00	34.00	1000PCS
2X17	32.00	36.00	1000PCS
2X18	34.00	38.00	1000PCS
2X19	36.00	40.00	1000PCS
2X20	38.00	42.00	1000PCS

20~40P

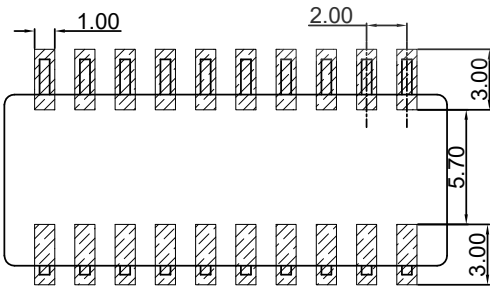

Recommended P.C.B Layout
General Tolerance±0.05

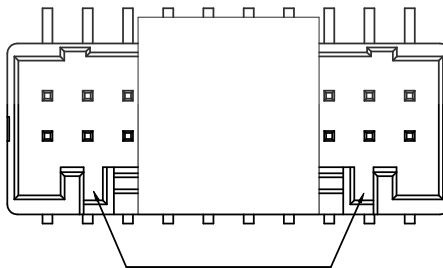

8~10P Without Guideway
12~40P With Guideway

Scale:1/0.5

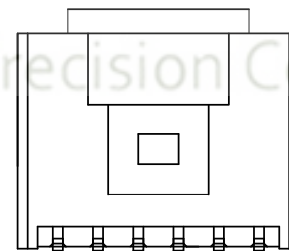

12~18P

XYCO 东莞市轩业电子科技有限公司
TEL: 0769-8297 9981/2/3 http://www.XYCO.com.cn

2022-07-18		A			XY20008-DXXXSVA-C1-BGE	Devin	XY20008-DXXXSVA-C1-BGE		UNIT 單位 mm		PRODUCT NAME 產品名稱		PUDP PH2.00mm Wire To Board SMT Vertical Double Row Wafer	
DATE 日期	VER 版本	CHANGE HISTORY 變更歷史	CHANGED NAME 修改後料號	DRAWING 變更者	TOLERANCE 公差 .X=±0.30 .XX=±0.20 .XXX=±0.10	DRAWING 設計者 CHECKED 審查 APPROVED 核准	Devin Thomas William	PART NO. 料號	DWG NO. 圖號	PE220705A				